

Version : 2020 Rev.0

Max – Rotovap



TABLE OF CONTENTS

Keep this manual on-hand so it can be used by all operators of the unit.
Use the unit only in the way described in this manual.
Failure to follow the instruction in this manual may cause wrong operation.

1. General Description	3
2. Structure and Components	4
3. Installation	5
4. Important Operation Instruction	6
5. Parts List	10
6. Specifications	11
7. Troubleshooting	12

1. General Description

Welcome to the world of MAX-ROTOVAP.

The most advanced and highest efficiency designed rotary evaporator on the market brought to you by Summit Research.

Easily surpassing all as the king of rotovaps with bone crushing recovery speeds.

This is the fastest rotovap on the market.

Features:

1. Only five main components including roto ball
2. Live vapor temp
3. Built in pre-heater to deliver feed fluid at any desired temp
4. Built in needle valve feed in and vacuum assisted ball evacuation valve
5. Solid no break lower drain valve adaptable to optional discharge pump
6. Dual condensers, reduced parts increasing efficiency design and never seen before with amazing results.
7. Touch screen
8. Increased heating capacity and quality of heat application technology
9. KF type fitting for vacuum
10. 21liters large collection jug
11. No bump system required, injection system solves the issue with bumping
12. Highest absolute quality components, no corners cut
13. Only triple coil with maximum condensing capacity on the market
14. Maximum ungraded turn motor
15. CNC precision vapor duct with 50L opening on the 20L model
16. Heavy duty rotational assembly

2. Structure and Components

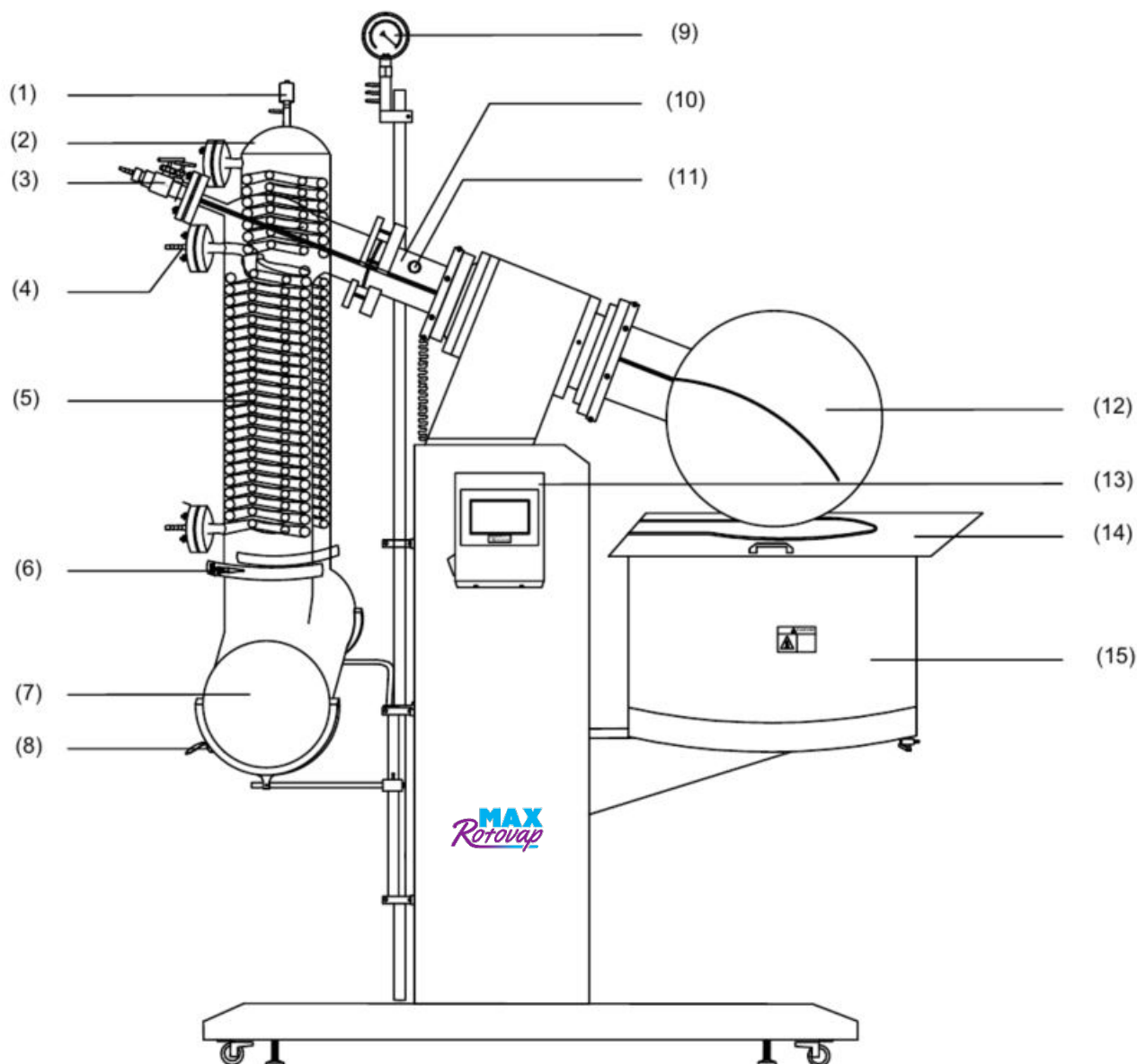

- | | | |
|-------------------------------|--|-------------------------------------|
| (1) PTFE valve | (6) Clamp for receiving flask | (11) Vapor sensor |
| (2) Auxiliary condenser | (7) Receiving flask | (12) Rotary flask |
| (3) KF16 vacuum valve | (8) Drain valve | (13) Touch panel controller |
| (4) KF16 adapter pipe fitting | (9) Vacuum gauge | (14) Support plate for rotary flask |
| (5) Main condenser | (10) Glass connecting pipe for vapor thermometer | (15) Water bath |

3. Installation

3.1 Stripping

1. Open the package, please check the parts according to the packing list. If there are any missing parts, please contact us.
2. Carefully clean the glass to maintain cleanliness before assembly.
3. Prepare all the tools you need for installation.

Note: The glassware set is fragile, please carefully unpack it!

3.2 Installation process

1. Insert small gasket and rotary glass shaft into the rotating mechanism from left side.
2. Insert big gasket and connect glass connecting pipe for vapor thermometer part.
3. Insert main seal ring into the rotating mechanism from right side and put support plate for rotary flask and position the rotary flask.
4. Put receiving flask on the support bracket and install main condenser, then adjust the position of receiving flask properly and connect them with O-ring and clamp.
5. Install auxiliary condenser and connect with receiving flask.
6. Insert feeding pipe and suction pipe into the main condenser and install vacuum valve.
7. Tighten the screws on flange snaps and drain valve.

Note: During the installation process, the glassware set should be handled gently, and the position of the flask mouth and the flask mouth should be appropriate to avoid damage the glass device!

4. Important Operation Instruction

- (1) After completing installation, check if there is no vacuum leakage due to imperfect assembly.
- (2) Do not run without water in tank. It will damage heaters.
- (3) After setting temp & rpm, run AT(auto-tuning) without adding materials (AT under no load) and please wait until AT is completed by itself.

4.1 Setting and Operation

(1) Controller overview



Press the power button, then press the **Start** button to begin.

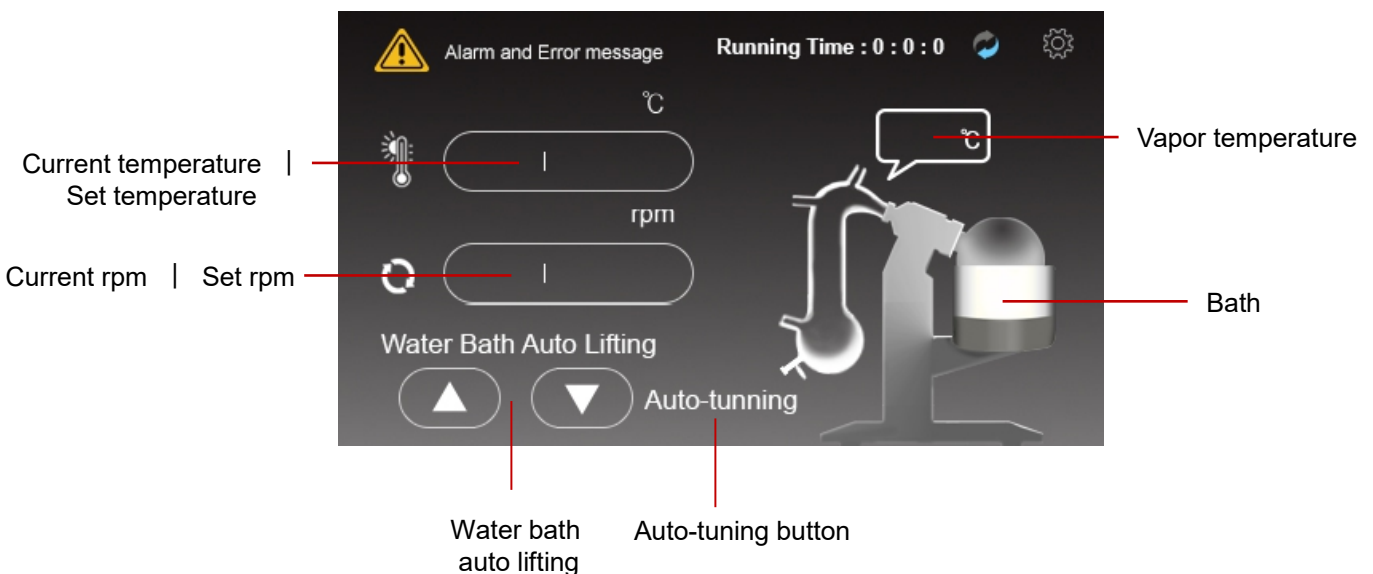

※ Max. Temperature is 150 °C, Max. RPM is 130rpm.

4.1 Setting and operation

(2) Temp setting



Click the screen as indicated above to display the numeric keypad when setting the temperature.
Set the desired temperature and press the **Enter** key.

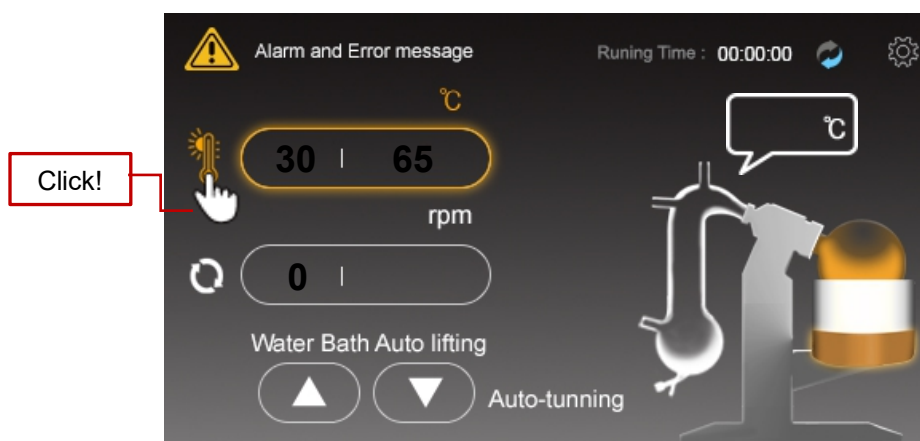

Click the thermometer icon to operate the equipment to the set temperature.

4.1 Setting and operation

(3) RPM setting

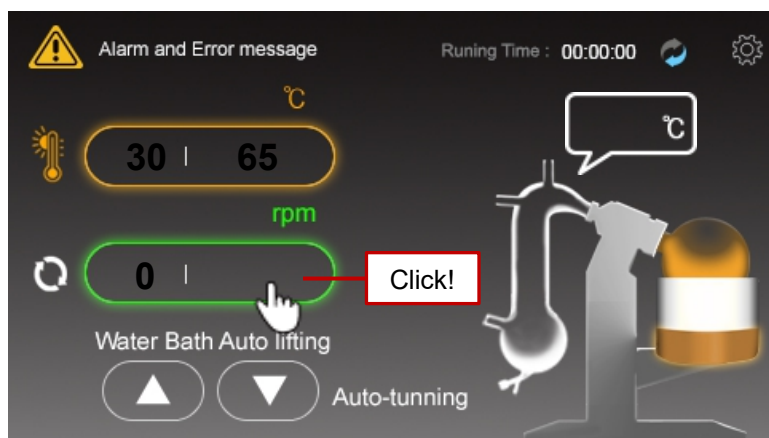

Use the numeric keypad to set RPM like the temperature setting.

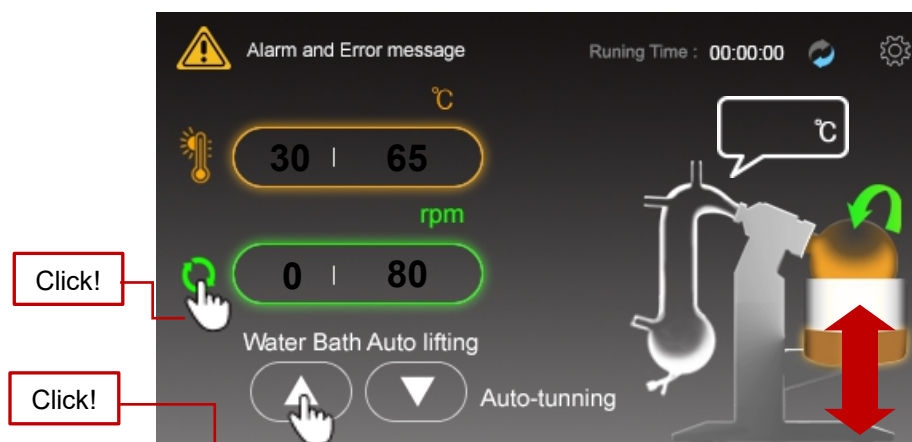

Click the rotate icon to operate the equipment to the set speed.
Use the up and down button of water bath auto lifting to adjust the location of water bath.

4.1 Setting and operation

(4) Auto-tuning(AT) setting

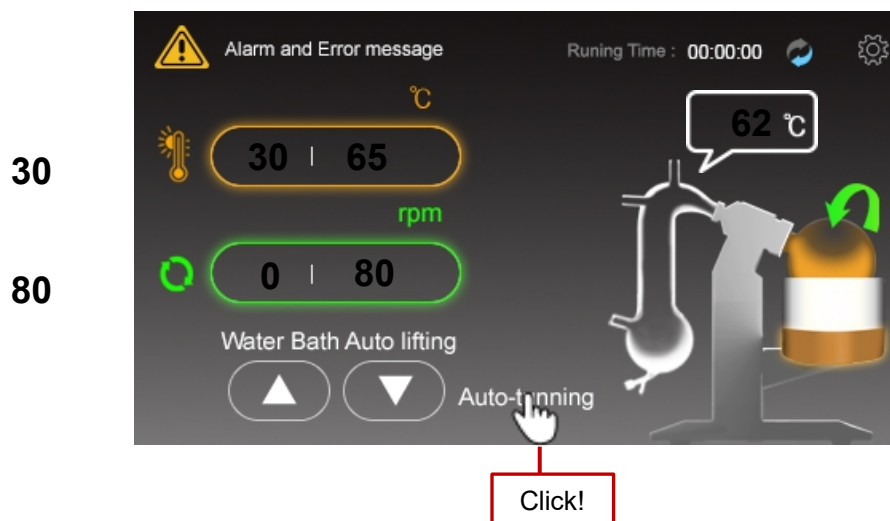

Click the **Auto-tuning** button to auto-tune.

(5) Troubleshooting

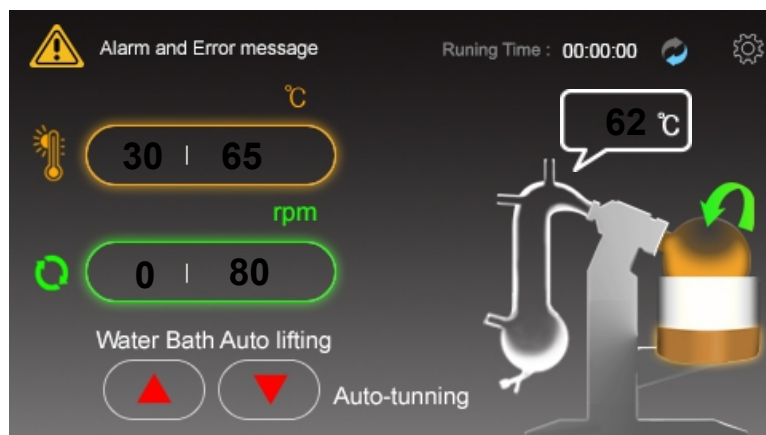

When the button of water bath auto lifting turns red as indicated above, then check the location of water bath and press the button to adjust.

5. Parts List

Product name: Max Rotovap 20L

NO.	DESCRIPTION	QTY	UNIT	REMARK
1	Glassware	1	SET	Main condenser, Auxiliary condenser, Receiving flask, Glass connecting pipe for vapor thermometer part, Rotary glass shaft, Rotary flask
2	O-ring for receiving flask	2	EA	
3	KF16/10 sealing adaptor /center ring	6	EA	
4	KF16 adaptor pipe fitting	5	EA	
5	KF16 vacuum valve	2	EA	
6	Vapor sensor	2	EA	
7	Teflon tube	2	EA	
8	Support for receiving flask	1	SET	Support bracket 2ea, Support rod 2ea
9	30 flange snap	8	EA	
10	Clamp for receiving flask	2	EA	
11	Ball milling clamp	1	EA	
12	Condenser strap	1	EA	
13	Feeding tube seal ring	5	EA	

NO.	DESCRIPTION	QTY	UNIT	REMARK
14	Main seal ring	1	EA	
15	Vacuum gauge	1	EA	
16	Drain valve	1	EA	
17	Support plate for rotary flask	1	EA	
18	PTFE valve	1	EA	
19	Touch panel controller	1	EA	
20	PCB board SET	1	SET	Control board, Temp controller, SSR, SMPS, Relay, MC
21	Level sensor	1	EA	
22	Lifting motor	1	EA	
23	Rotating motor	1	EA	
24	Heating coil	1	SET	

6. Specifications

Model	Max Rotovap 20L
Glass Material	GG-17 High Borosilicate
Rotation Motor	DC 300w
Lifting Motor	40w, 1250rpm
Power (V/Hz)	220V 60Hz Single Phase
Vacuum Seal	PTFE + Teflon coating
Temperature Control	PID Controller
Maximum Rotation Speed	130rpm
Evaporating Flask Capacity	20L / 5.28 gallon
Receiving Flask Size	(L) 27", Ø 7.9"
Condenser Style	Main + Auxiliary Vertical Double Helix
Water Bath Material	Stainless steel corrosion resistant coating
Water Bath Size	Ø 450 x 310mm / Ø 17.7" x 12.2"
Bath Temp. Control Range	0 ~ 150 °C
Lift Mode	Auto lift
Heating Power	5000w
Packing Dimension	(L) 48" x (W) 28" x (H) 61"
Gross Weight	150kg / 331lbs
Net Weight	120kg / 265lbs

7. Troubleshooting

Symptoms	Reason of failure	Troubleshooting method
Turn on the power switch, light does not light	The power plug is unplugged or plugged not well.	Set the power switch to the OFF position then insert the power plug into the socket.
	Control board has failure.	
Power switch indicator light, but does not rotate	Control board has failure.	Please stop using it immediately and contact the supplier of this product.
	The motor has failed.	
	Rusty bearings	
Rotary flask oscillation	Internal gear wear.	Please reinstall the rotary flask and tighten all screws.
	The installation for rotary flask is not good.	
	The screw of rotary flask is unlocked.	
Abnormal sounding	Sealing wear.	Please replace the sealing.
	Internal gear wear.	Please reinstall the rotary flask and tighten all screws.
	Drive lack of oil.	
	The motor has failed.	
Pressure leak vacuum is not good	Vacuum seal ring wear.	Please replace the vacuum seal ring.
	Rotary glass shaft wear.	Please replace the rotary glass shaft.
	O-ring of ball joint wear.	Please replace the o-ring of ball joint.

