

# Techno -Heat Mantle

2L, 5L, 12L, 22, 50L



# Table of contents

Keep this manual on-hand so it can be used by all operators of the unit.  
Use the unit only in the way described in this manual.  
Failure to follow the instruction in this manual may cause wrong operation.

1. General description	3
2. Graphic symbols	4
3. The outward	5
4. Basic parts	8
5. Installation	9
6. Specification	10
*Meaning of temperature displayed in screen	12
7. Setting and operation	13

## 01. General description

---

Thank you for purchasing our product.

We know that in today's competitive marketplace, customers have many choices when purchasing laboratory equipment.

We appreciate you choosing our quality product.

We stand behind our products and want to let you know we are here if you need us.

Before you use this unit, read this entire manual carefully to understand how to install, operate and maintain the unit in a safe manner.

Your satisfaction with the unit will be maximized as you read this manual thoroughly.

Please also note that your mantle is pre-calibrated from our shop.

The Techno Heat Mantle adopts a touch screen display, making it easy to navigate screens and monitor the operation.

Furthermore, this Techno-heat mantle set contains 3 kinds of interfaces; it's capable of storing the testing data using USB and it can be remote accessed by smart phone. RS232C enables communication with PC.

## 02. Graphic symbols

BE SURE THAT YOU UNDERSTAND ALL OF THESE SYMBOLS BEFORE OPERATING THE UNIT.



Important operating and / or maintenance instruction.  
Read the accompanying text carefully.



This symbol indicates items and procedures that are **STRICTY PROHIBITED** with regards to the unit.



Potential electrical hazards.



Explosive.



No disassemble.



Flammable.



Hot surface or steam.

### 03. The outward <Techno-heat>

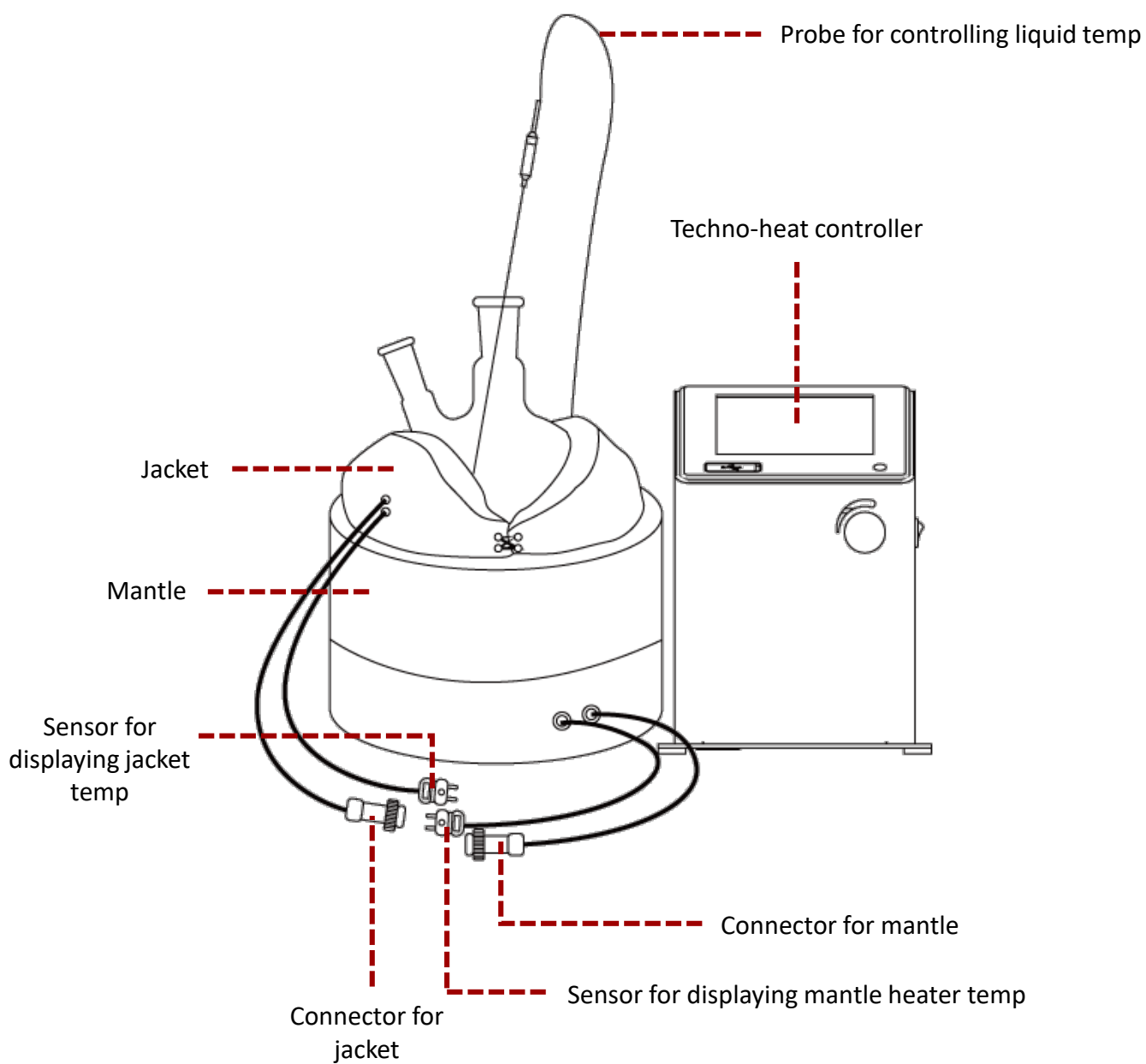

<2L, 5L>

## 04. The outward <Techno-heat>

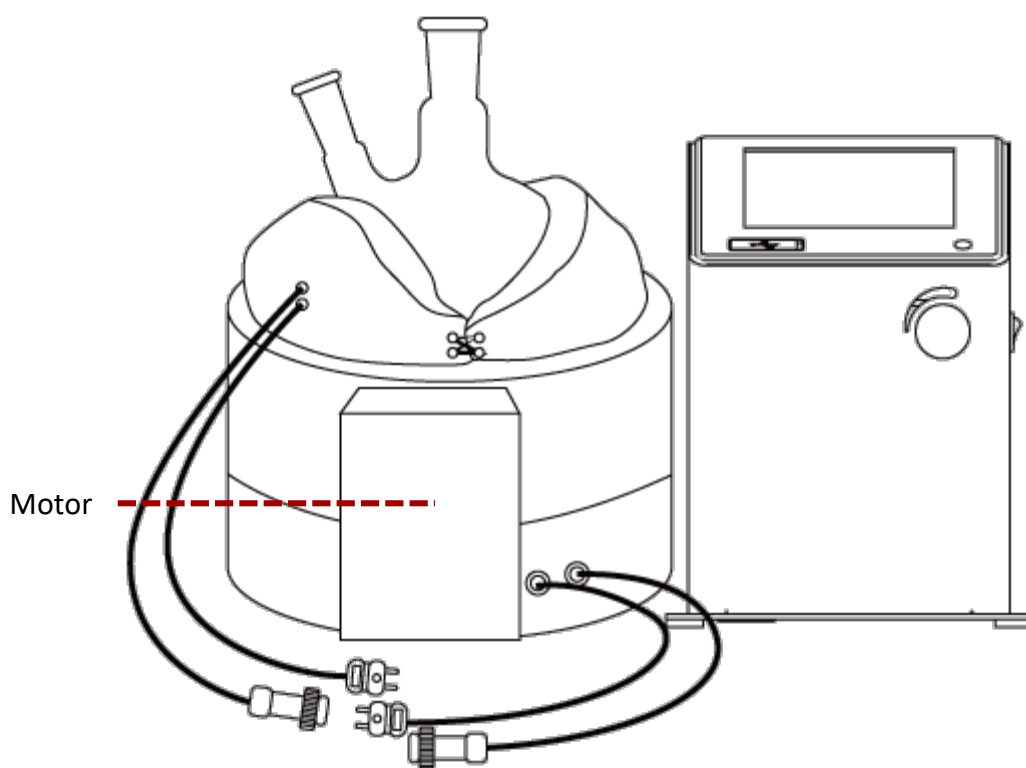

**<12L, 22L>**

## 04-1. The outward <Techno-heat controller>

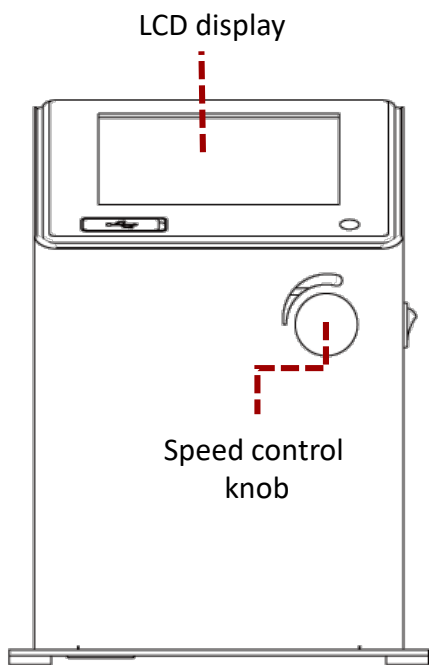

<Front>

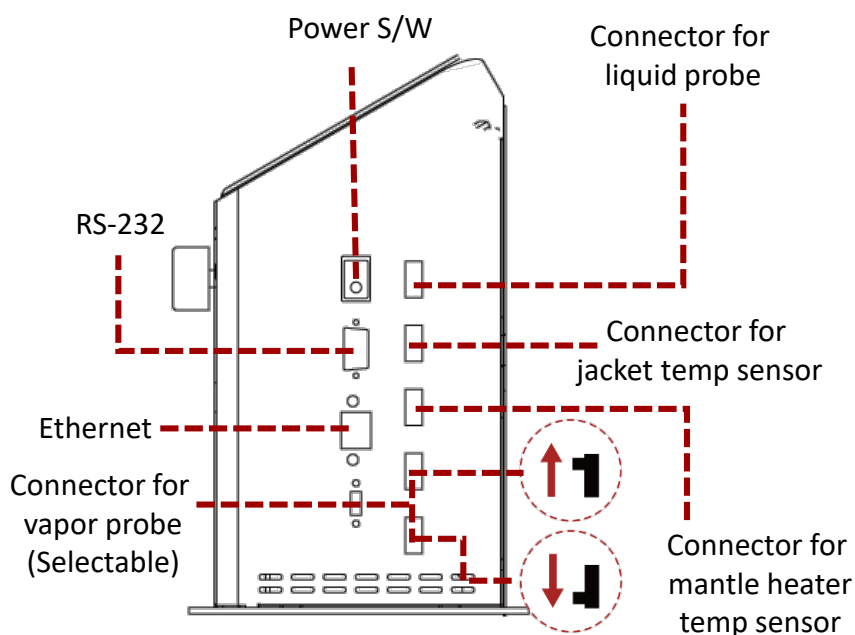

<Side>

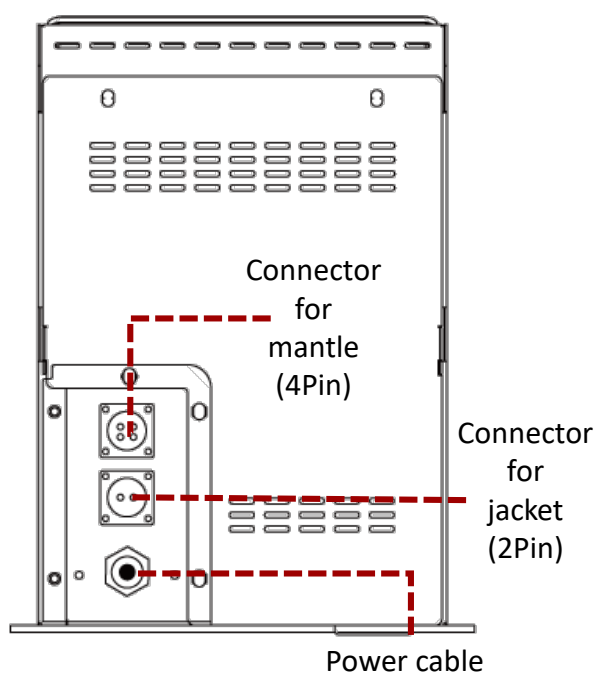

<Back 2L, 5L>

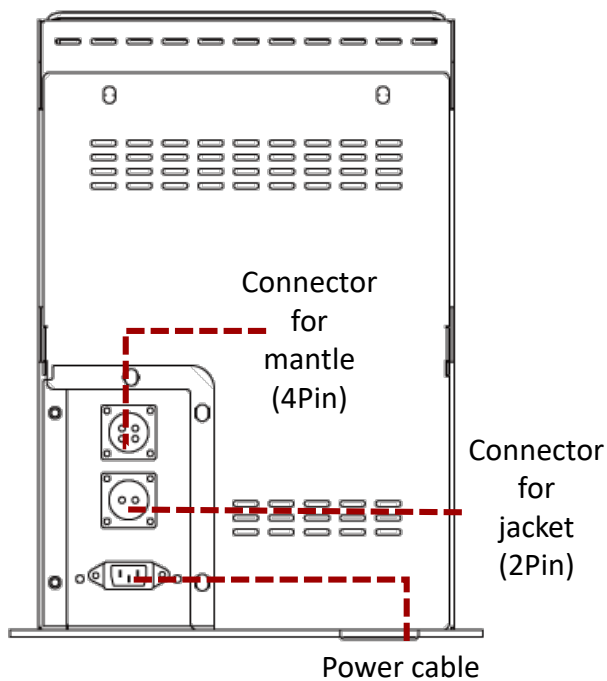

<Back 12L, 22L>

## 04. Basic parts

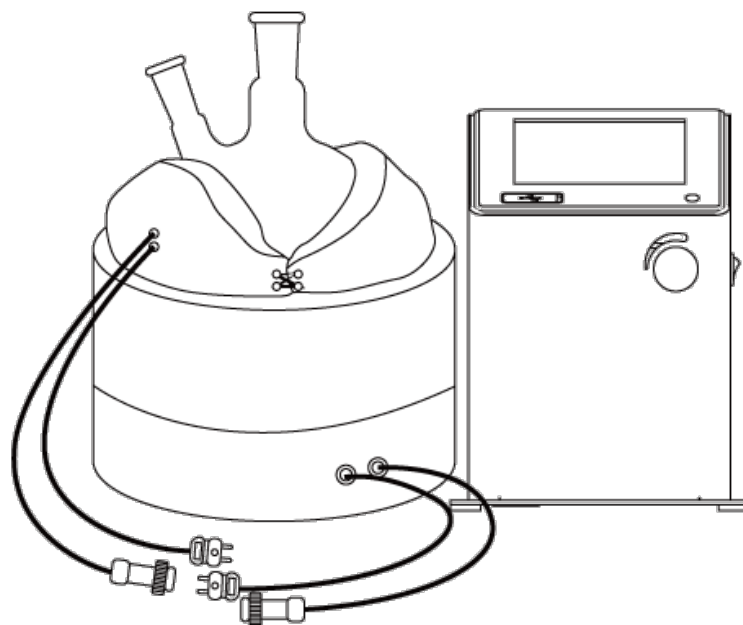

<Main unit>

+

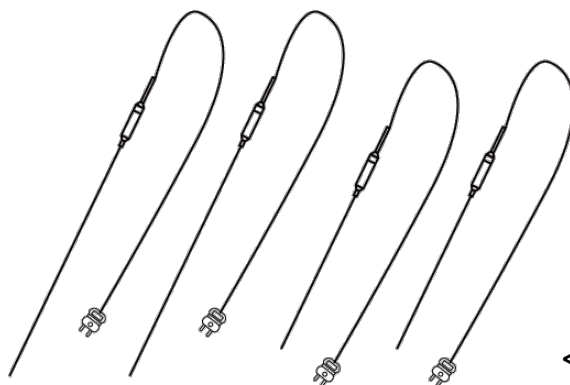

< Sensor >

Capa	Liquid Sensor & Q-ty	Vapor Sensor & Q-ty
2L	400mm(15.74inch), 2EA	150mm(5.9inch), 2EA
5L	400mm(15.74inch), 2EA	150mm(5.9inch), 2EA
12L	600mm(23.62inch), 2EA	150mm(5.9inch), 2EA
22L	600mm(23.62inch), 2EA	150mm(5.9inch), 2EA
50L	750mm(29.53inch), 2EA	150mm(5.9inch), 2EA



## 05. Installation

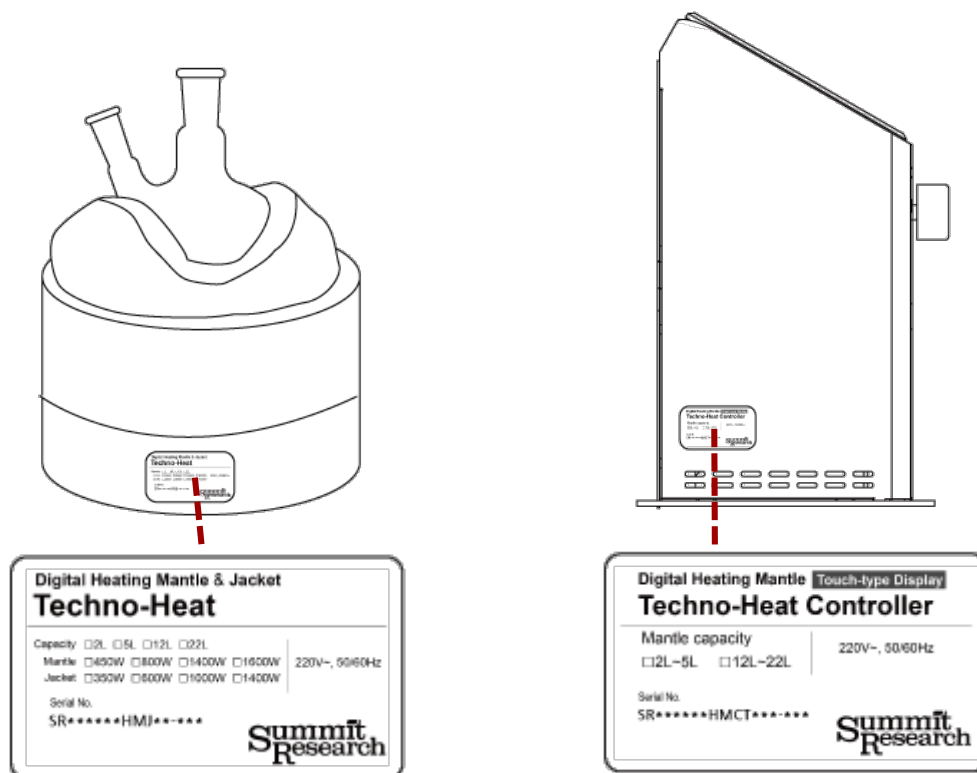

Serial label shows the electric power specification of the unit.  
Connect power and turn on the main switch.

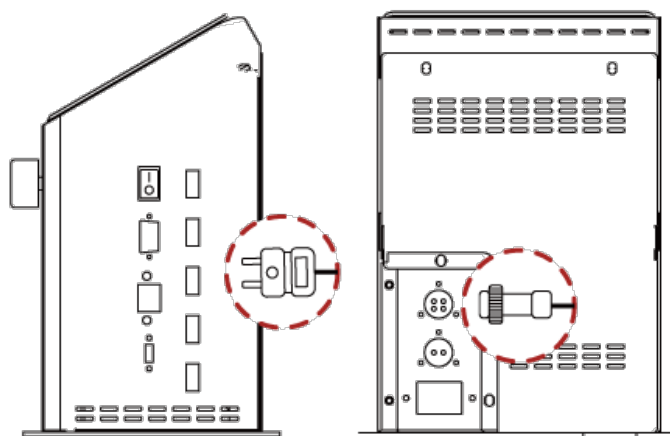

Connect the power cable, jacket and mantle to the controller.  
Connect each sensor cable to the controller and turn on the main switch.

## 06. Specifications

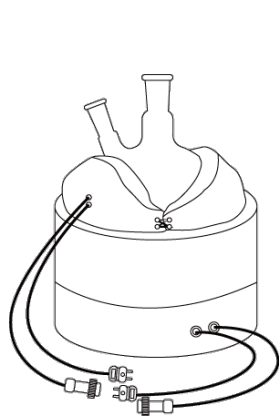

**<2L, 5L>**

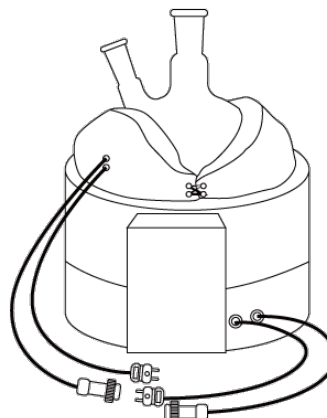

**<12L, 22L>**

Capacity	2L	5L	12L	22L	50L
Dimension	Φ270x220mm Φ10.62x8.66"	Φ330x220mm Φ12.99x8.66"	Φ400x300mm Φ15.74x11.81"	Φ450x330mm Φ17.71x12.99"	Φ600x450mm Φ23.62x17.72"
Jacket Heater	220V, 350W	220V, 600W	220V, 1000W	220V, 1400W	220V, 1500W
Mantle Heater	220V, 450W	220V, 800W	220V, 1400W	220V, 1600W	220V, 3000W
Motor	10W	10W	60W	60W	60W
Net Weight	3 kg / 7lb	3.9 kg / 9 lb	15 kg / 33 lb	18.5 kg / 41 lb	34 kg / 75 lb
Gross Weight	5 kg / 11lb	6 kg / 13 lb	20 kg / 44 lb	22 kg / 49 lb	50 kg / 110 lb

## 06. Specifications

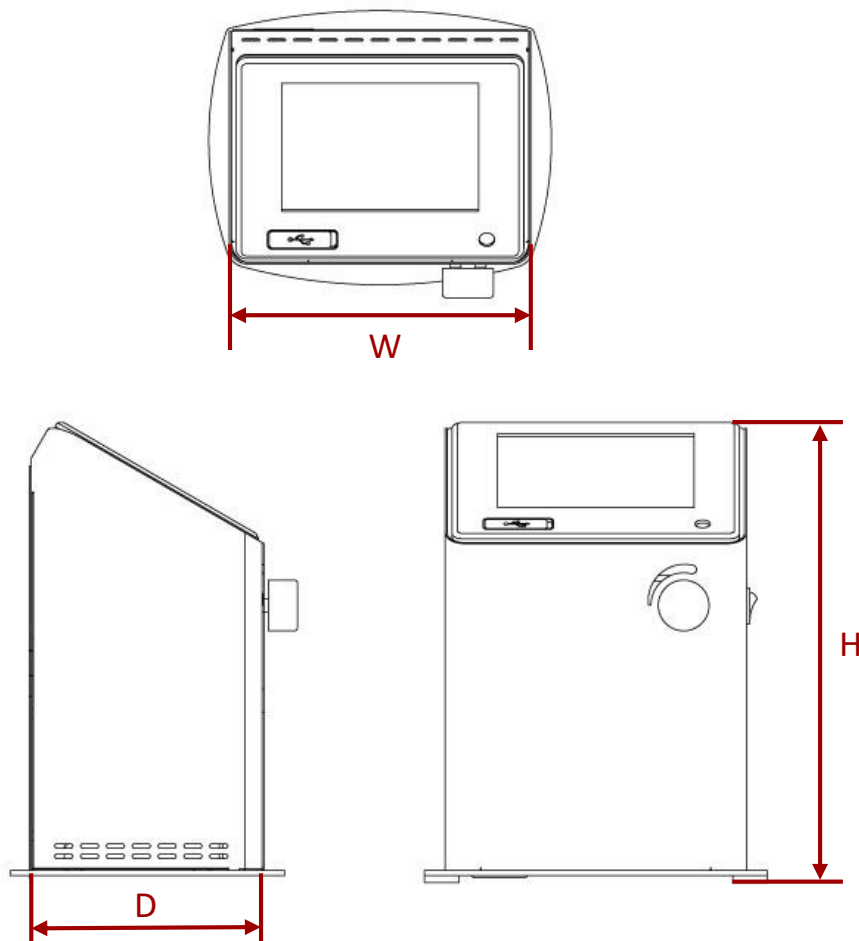

Product	LCD Controller
Dimension(WxDxH)	175x135.3x260mm 6.89x5.33x10.24inch
Power Supply	220V, 50/60Hz
Net Weight	4 kg / 9 lb
Gross Weight	5 kg / 11 lb

## \*Meaning of temperature displayed in screen

Operation			
①	SV	0.0 °C	Setting temp for liquid
②	PV	0.0 °C	Real temp for liquid
③	SV	0.0 °C	Setting temp for jacket
④	PV	0.0 °C	Real temp for jacket
⑤	AV	0.0 °C	Alarm temp for mantle heater
⑥	PV	0.0 °C	Real temp for mantle heater
⑦	AV	0.0 °C	Alarm temp for vapor
⑧	PV	0.0 °C	Real temp for vapor

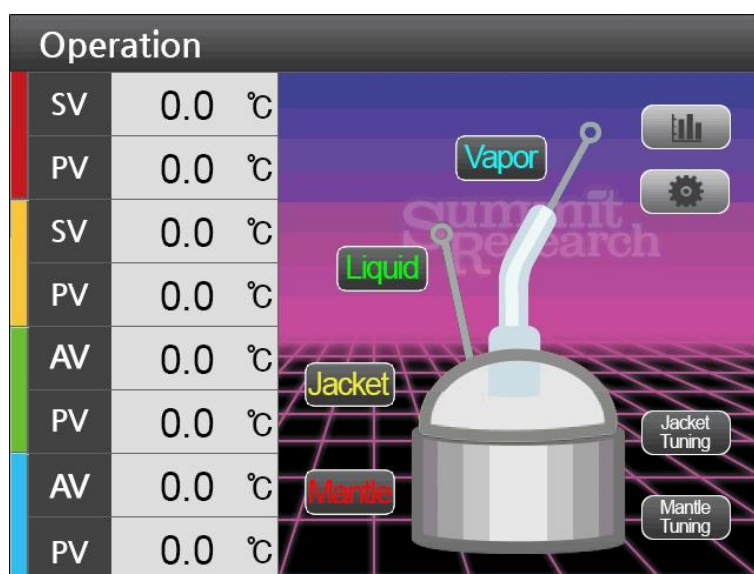

The following steps have been performed on your Techno Heat Mantle in our shop. If you need further support with your pre-calibrated unit, please call Summit 831-226-2948

1. Set ① and ③ as 150°C.
2. Set ⑤ and ⑦ as 0 °C (AV is deactivated).
3. Click mantle(or CH 1), jacket(or CH 2), liquid(or CH 3) and Vapor(or CH 4) and let them run.
4. Click jacket and mantle tuning.
5. Wait till tuning is done. It may take a few hours.

# 07. Setting and operation

## 1. Techno-Heat Digital Touch Panel Controller

(1-1) Click Start button

(1-1)



## 2. How to Activate and Deactivate

- (2-1) Click Mantle button
- (2-2) Select Yes or No. If you select YES, PV in Mantle will be NONE
- (2-3) Click Mantle button again to make it Reactivate.
- (2-4) Click YES
- (2-5) Mantle becomes to Activate.
- (2-6) The method is same for other buttons.

(2-1)

(2-2)

(2-3)

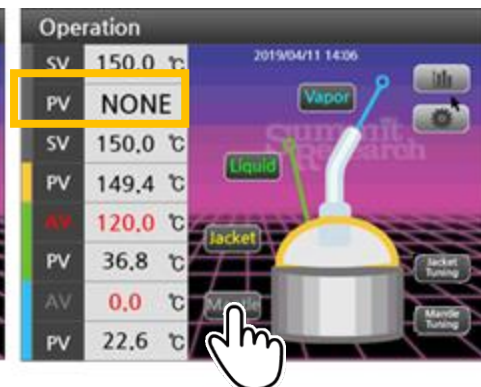
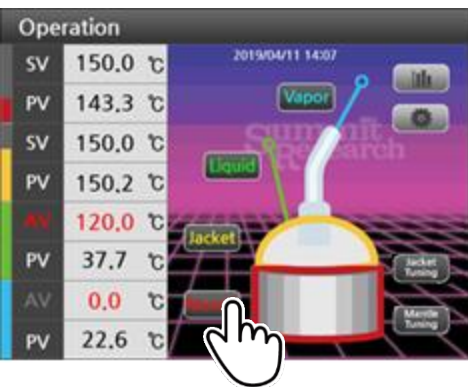

(2-4)

(2-5)

(2-6)



### 3. How to set SV(Setting Temperature value)

(3-1) Click Mantle area or Mantle SV

(3-2) Set SV and enter

(3-3) The method is same for Jacket

(3-1)

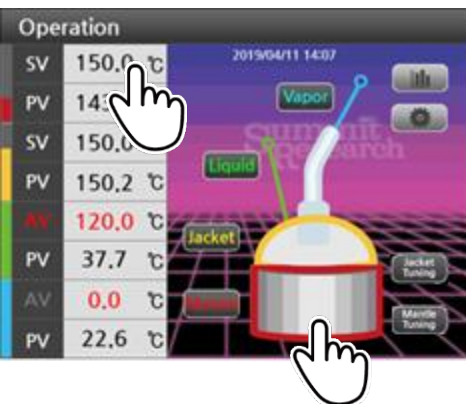

(3-2)



(3-3)

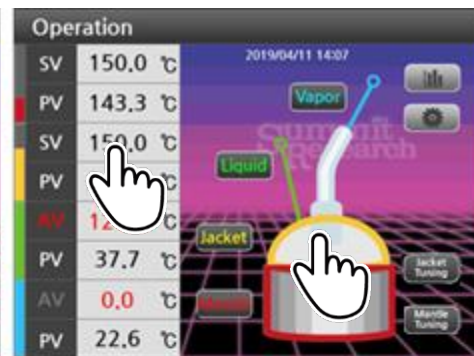

### 4. How to set AV (Setting Alarm Temperature value) – Mantle, Vapor

(4-1) Click AV

(4-2) Set alarming temp and enter

(4-3) The method is same for Vapor

(4-1)

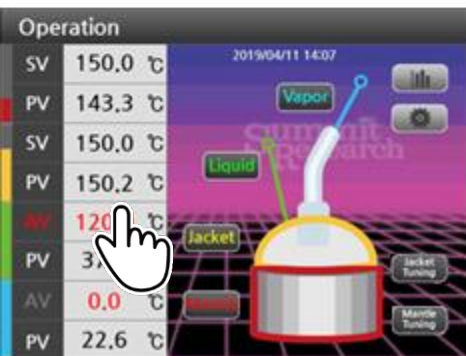

(4-2)



(4-3)



## 5. How to Activate and Deactivate for AV – Liquid, Vapor

(5-1) Alarm starts when PV reaches to AV

(5-2) If you want Alarm off, set AV higher than PV or set AV as 0.0 °C

(5-3) If you want to reactivate Alarm, click AV and it will show 1370.0 °C initially. And then you can set AV as you like.

(5-1)

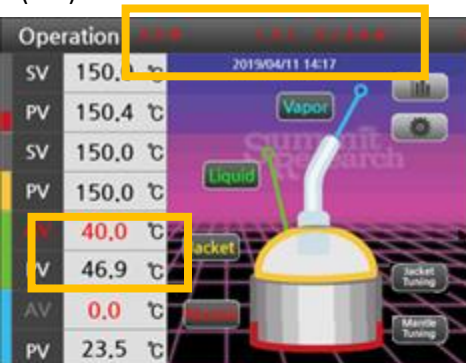

(5-2)



(5-3)



## 6. How to do Mantle, Jacket Tuning \*Reminder, your mantle comes pre-calibrated in our shop.

(6-1) Click Mantle Tuning

(6-2) Click YES to start Mantle Tuning (The icon will change to red and be blinking until tuning is completed)

(6-3) If you want to stop Mantle Tuning, click the Icon and click YES

(6-4,5,6) The method is same for Jacket

Summit uses special tools to calibrate,  
 please call us if you think calibration is off  
 831-226-2948

## 7. How to retrieve graph

- (7-1) Click graph button
- (7-2) Graph 1 is line graph
- (7-3) Graph 2 is bar graph

(7-1)

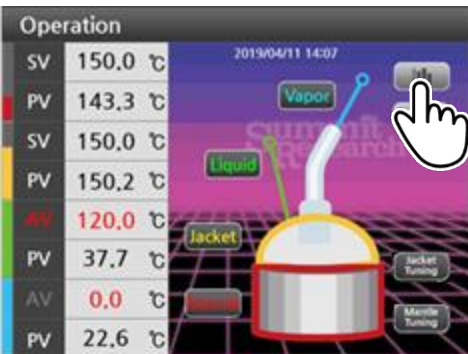

(7-2)

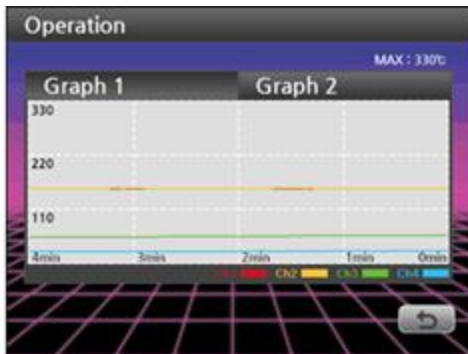

(7-3)

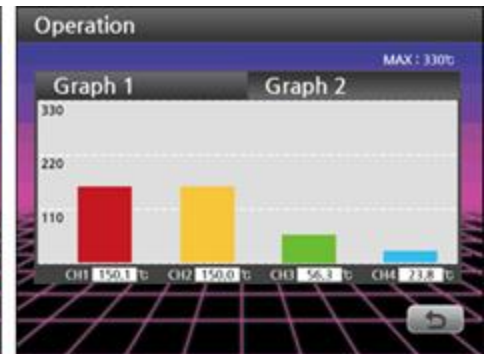

## 8. Setting

- (8-1) Click setting button
- (8-2) Put password "1234".
- (8-3) Temperature Sensor. Can not change
- (8-4) P.I.D (Mantle, Jacket). After Auto Tuning, ideal PID value is set automatically.
- (8-5) Alarm (Alarm Value, Hysteresis )
- (8-6) Etc (BIAS , High Set limit)
  - BIAS is Offset setting
  - High Set Limit is max temperature setting (Max is 300)

(8-1)



(8-2)



(8-3)

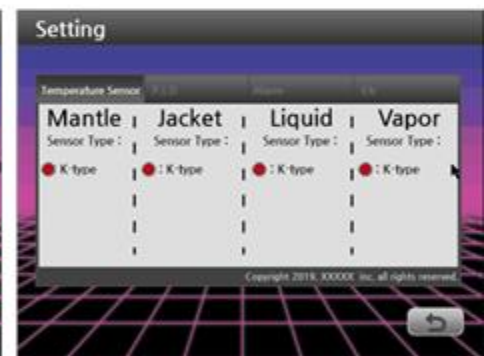

(8-4)



(8-5)



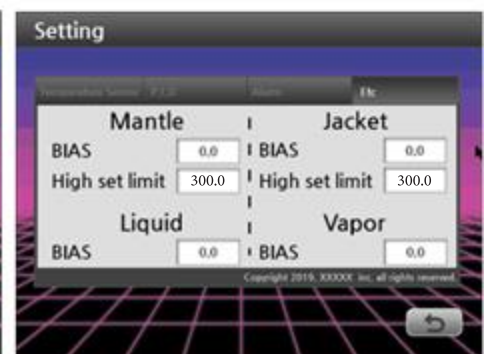

(8-6)





## 9. Error

- (9-1) In case of over temperature,  pops up and alert message is shown in the screen.
- (9-2) In case of sensor disconnection of Mantle and Jacket, PV will become 1448.5°C and  pops up and alert message is shown in the screen.
- (9-2) In case of sensor disconnection of Liquid and Vapor, **ERROR** will be shown and alert message is shown in the screen.

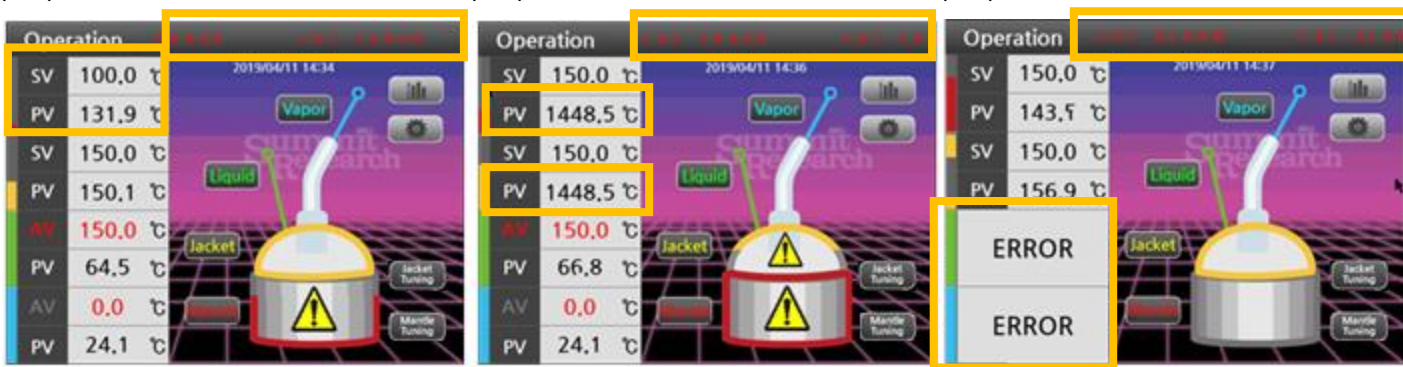

## 10. System Configuration > Network Setting

There are 2 ways for Network connection: Initial Company IP and IP router. Therefore, it's necessary to decide which type IP you want to connect before Network setting.

10-1. In case of Initial IP address connection

- (10-1-0) Connect the initial IP LAN cable to the controller.
- (10-1-1) Click  button
- (10-1-2) Enter password 0000
- (10-1-3) Click Network and click LAN. Click Static IP and copy Static IP, Subnet Mask, Gateway. This information shall be provided by Network manager.
- (10-1-4) Click Apply.
- (10-1-5) Click VNC, put your password and click Start and Apply. (This password is necessary for PC and mobile phone access.) Then, it's ready to access to VNC viewer.

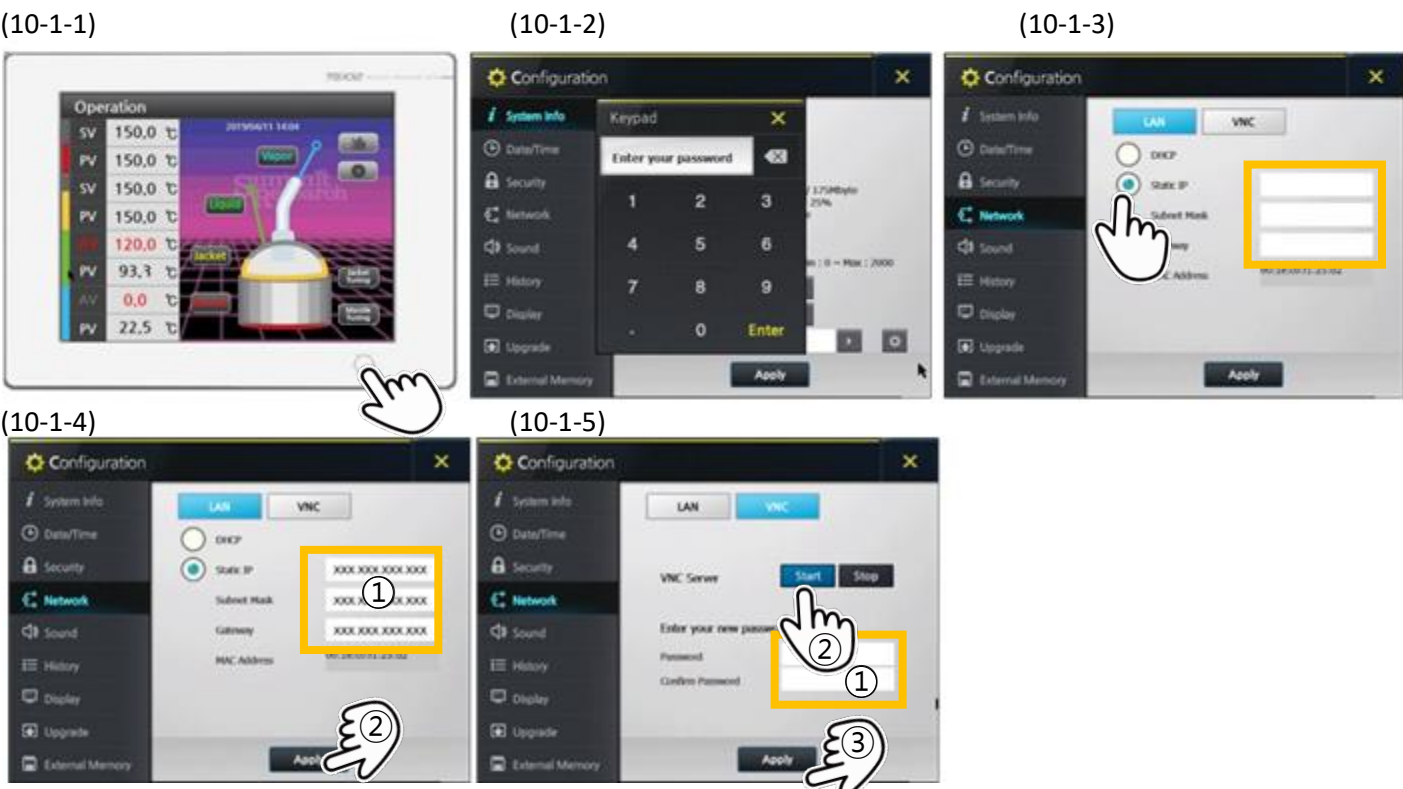

## 10. System Configuration > Network Setting

10-2. In case of IP router connection

(10-2-0) Connect the LAN cable to the controller.

(10-2-1) Click  button

(10-2-2) Enter password 0000

(10-2-3) Click network and click LAN. Then, Static IP will show initially and no data.

(10-2-4) Click DHCP and it will show Static IP, Subnet Mask and Gateway . Note them.

(10-2-5) Click Static IP and copy Static IP, Subnet Mask, Gateway from DHCP. Click Apply.

(10-2-6) Click VNC , put your password and click Start and Apply.

(This password is necessary for PC or mobile phone access.)

Then, it's ready to access to VNC viewer.

(10-2-1)



(10-2-2)

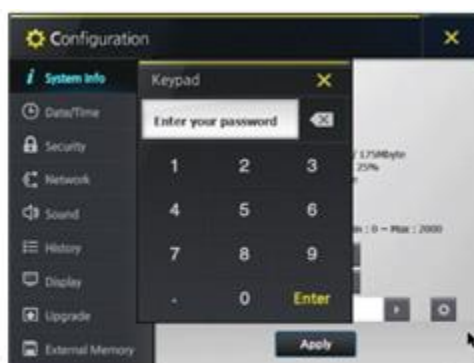

(10-1-3)

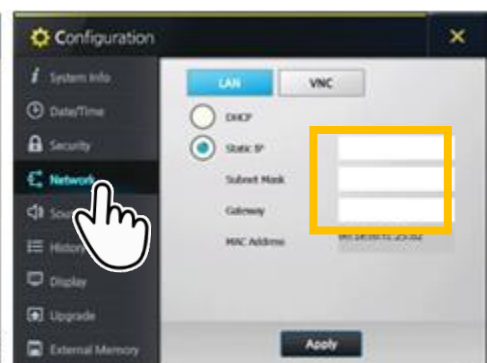

(10-2-4)

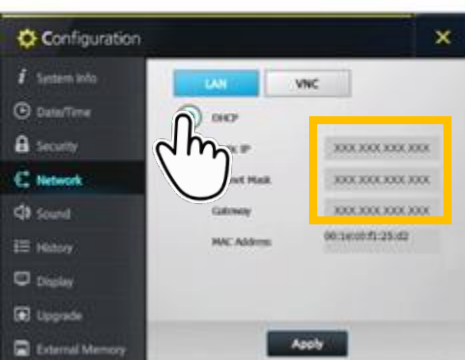

(10-2-5)

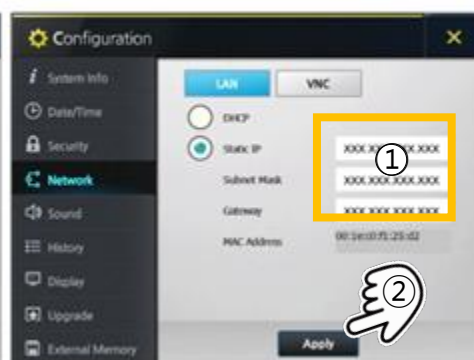

(10-2-6)

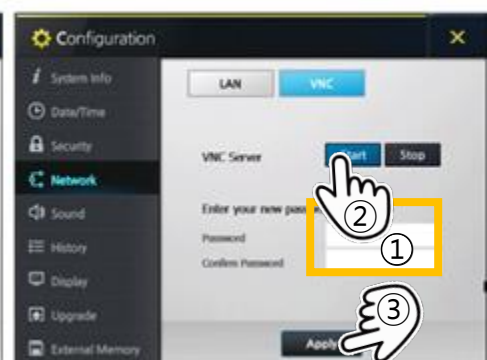

## 11. How to use VNC viewer

The VNC viewer enables to monitor the operation status and remote control is available if you're in- and out of network.

(11-1) Download VNC viewer in App store of iOS system and in Google Play of Android system.



(11-2) (11-2) Create the new account: Put your full email address, name, phone number, company and country.

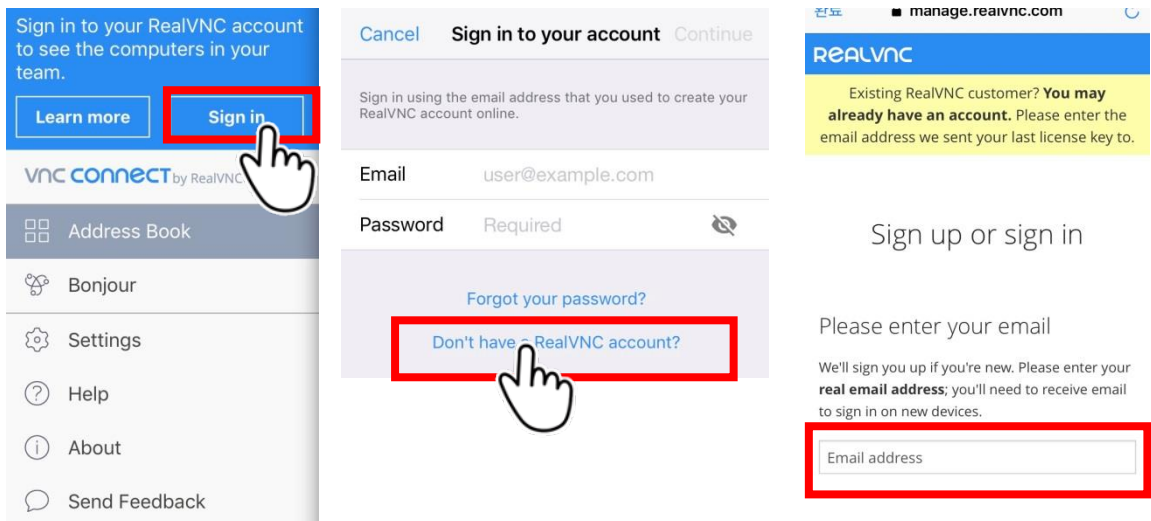

(11-3) After registration, you'll get the verification email and need to verify at your mail box. Then, you're ready to sign in "VNC viewer" on your mobile phone.

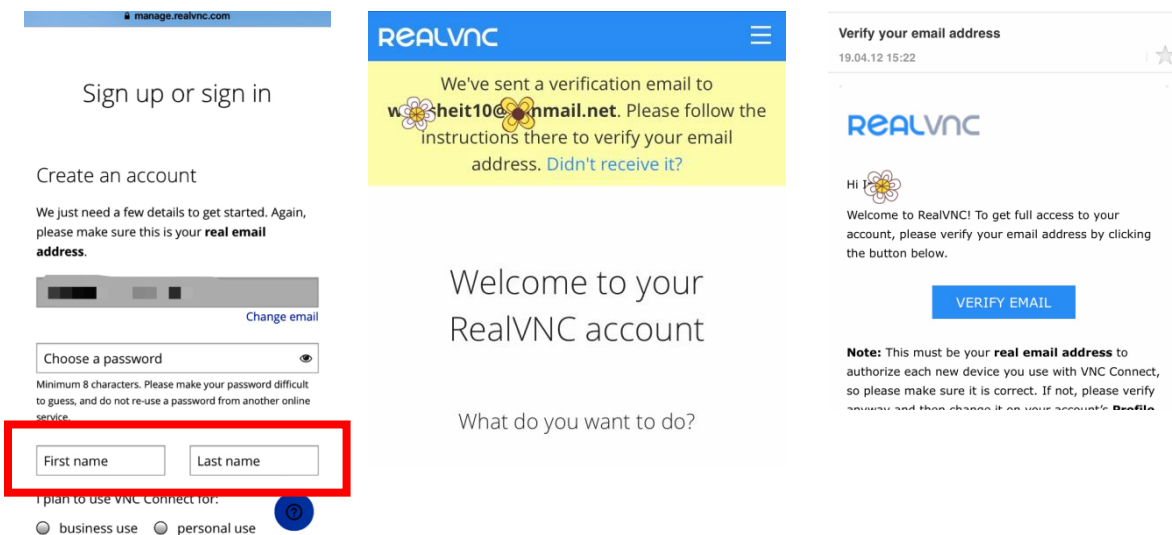

(11-4) Put your email address and password and sign in your mobile phone.

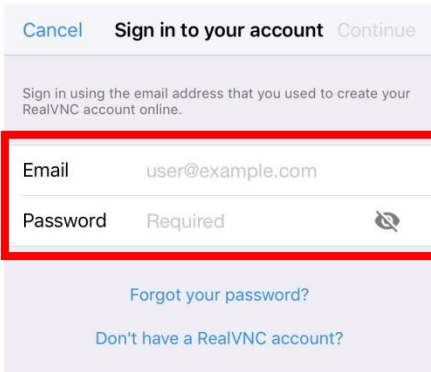

(11-5) Click Address Book and click + to add new IP address you want to access to.

If you're in Network, put the IP router address.

If you're out of Network, put the initial Company IP address. (Initial IP shall be provided by Network provider) and save.

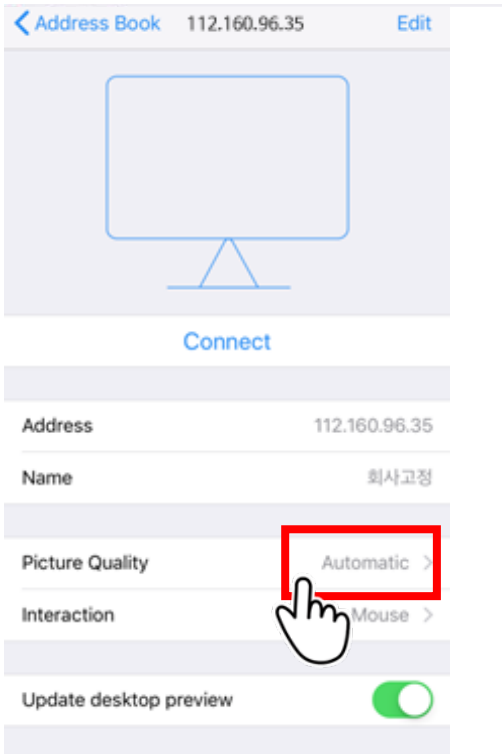
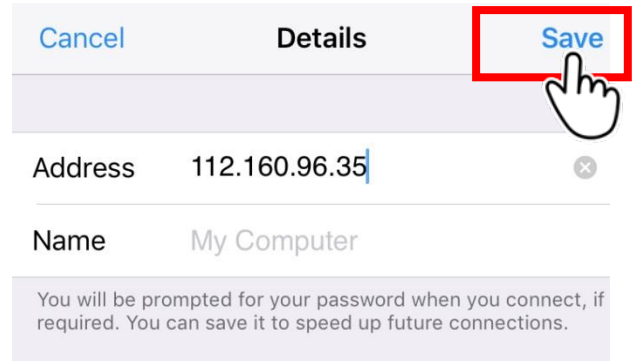
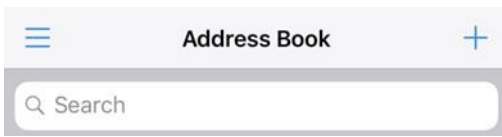

(11-6) Click Picture quality.

It will show "Automatic" initially and it must be adjusted to High.

**Select High and return backward.**



(11-7) Then, Picture Quality becomes High. Click Back and the new added IP address shows as below.

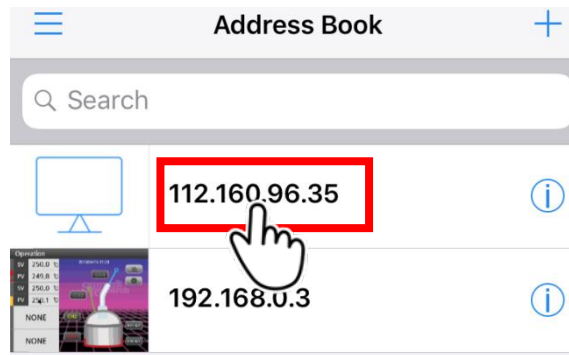
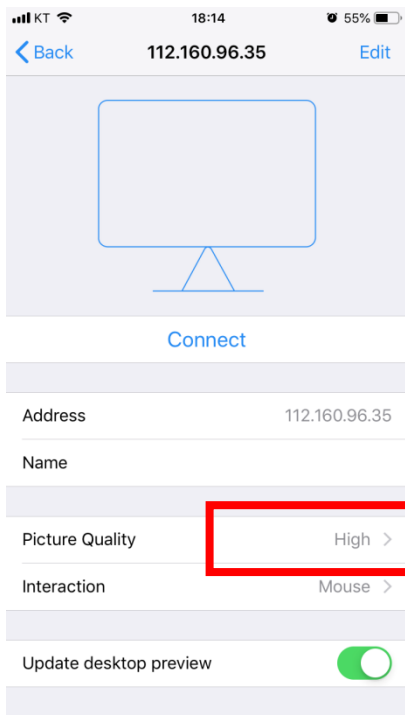

(11-8) Now you're ready to access through mobile phone.

(11-9) Click the IP address for access.

If access is failed, close the App completely and activate the app again.

(11-10) After reactivate the App, click the IP address .

In Encryption, click “Connect” and put the access password. (same password of VNC network setting in Controller)

Then, controller screen will display on your mobile phone.

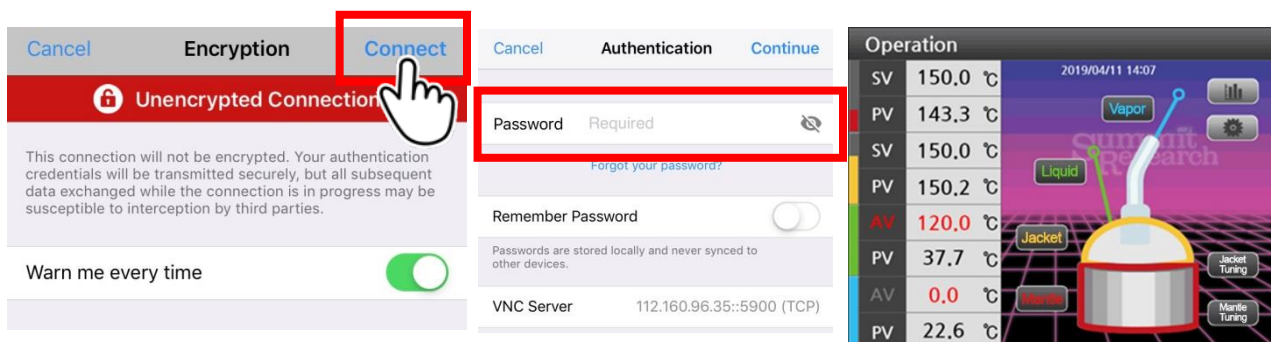

(11-11) To change any value on mobile phone, click the cursor and drag it to the position to change the value.

Then, adjusted value will be applied immediately on mobile phone and controller unit as well.

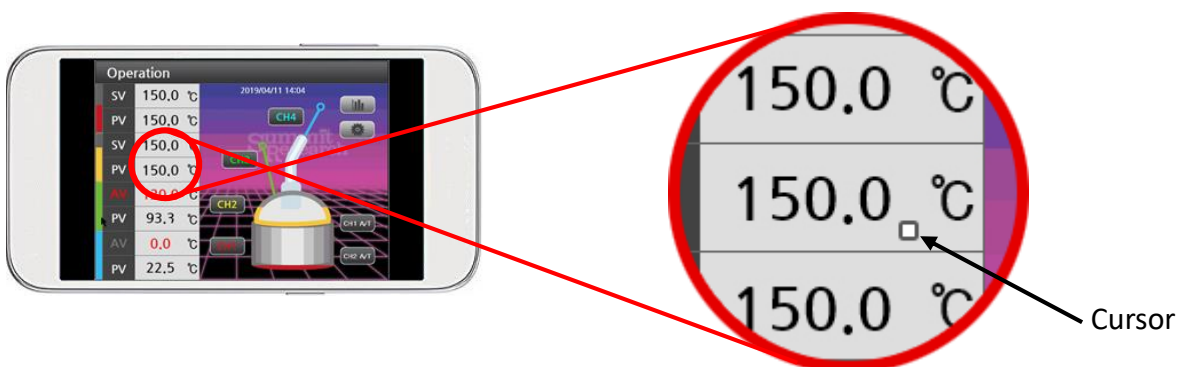

## 12. How to use USB storage.

(12-1) Open the rubber cover on the front panel. There are a USB port and a Mini USB port. Mini USB port is for software update.

(12-2) Connect the USB. Then, it will create the PV folder and excel files by every day automatically. And testing data will be saved in an excel file by every minute.

(12-3) Disconnect the USB storage and connect to the PC. You can see the test data in Excel files.

